



In-Between Handling Lift Trucks

TECHNICAL DATA

ELECTRICAL SYSTEM

Model 1018: 12V, 105 A.H. polycase lead acid battery and built-in 8 amp. charger.

Models 1518, 2018: 12V, 125 A.H. polycase lead acid battery and built-in 8 amp. charger.

Models 1524, 2024, 2524: 12V, 155 A.H. polycase lead acid battery and built-in, fully automatic 15 amp. "smart" charger.

STRUCTURAL SYSTEM

Mast construction utilizes premium alloy, structural channel and I-beam.

Inner mast and carriage are fully rollered with tapered bearings. Dual lift chains

Rigid steel chassis, welded distortion-free.

Shaft-type forks for easy adjustment.

Tubular straddles on 1018/1518/1524/2018 series.

Solid bar straddles on 2024/2524 series.

HYDRAULIC SYSTEM

Infinitely variable ball-type lowering valve provides full range operator control and no-drift check in neutral.

Gear pump is sized to lift requirements to provide good performance at modest power draw.

Full system filtration is provided on the intake side of the pump which prevents foreign matter from entering any part of the system.

Built-in relief valve protects system from overload.

Pressure-compensating flow control valve at base of lift cylinder on telescopic models regulates lowering speed.

Reservoir is removable and comes equipped with foam-filter cap.

Chrome plated lift cylinder rod provides smooth lift/lower operation and long life.

SAFETY FEATURES

Dual, adjustable and slip-resistant floor locks for secure positive grip.

Flow control valve on telescopic models.

Screen guard.

Dual chain.

Keylock to prevent unauthorized usage of truck.

OPTIONS

36" wide carriage.

Fully automatic 15 amp. charger.

Steer wheel.

AC controls — 110V-1Ø-60HZ, 220V-1Ø-60HZ and 220V-3Ø-60HZ.

Adjustable restrictor valve.

Adjustable straddles - 38" to 50" I.D. at 4" increments.

Charger light on dash panel.

Lift limit switch w/ override.

Lift limit switch w/o override.

Load backrest.

Remote lift/lower...from pushbutton station.

See wheel options under "wheels".

CERTIFICATION

ANSI B56.10

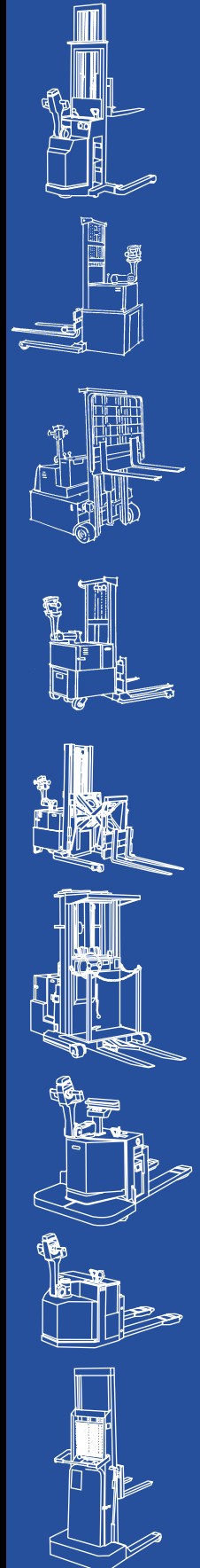

Big Lift LLC
1060 N. Garfield Street, Lombard IL 60148
Phone 630-916-2600 • Fax 630-916-0667
www.bigjoeforklifts.com

Big Joe Manufacturing Company will not assume liability for injuries or damage arising from, or caused by, the removal of any safety devices from their vehicles by user. Because of the Big Joe policy of continuing product improvements, specifications are subject to change without notice.



In-Between Handling Lift Trucks

STANDARD EQUIPMENT

- **High Strength Construction.**
High grade steel mast construction features interlocked channel and I-beam design with roller bearing surfaces. Mast and carriage is of fully-rollered construction for smooth, long-wearing performance. This type of construction accommodates high lifting stresses and maintains load stability.
- **Infinitely Variable Lowering Valve.**
Ball-type lowering valve provides full range operator control and no-drift check in neutral.
- **Electrical System.**
Lift motor is specially selected for peak efficiency at torque and RPM lift pump requirements. All cables and wiring are color-coded and/or numbered for easy servicing.
- **Floor Locks.**
Dual, adjustable and slip resistant for secure positive grip.
- **Gear Pump.**
Sized to lift requirements to provide peak performance at modest power draw.
- **Full System Filtration.**
Provided on the intake side of the pump. Prevents foreign matter from entering system.
- **Built-In Relief Valve.**
Protects system from overload.
- **Chrome Plated Lift Cylinder.**
Provides smooth lift/lower operation and long life.
- **Shaft-type Forks.**
Allows easy adjustment.
- **Pressure-Compensated Flow Control Valve.**
Located at base of lift cylinder, regulates lowering speed (on telescopic models only).
- **Rigid Steel Chassis.**
Continuous seam-welded distortion-free.
- **Wheels.**
4" steel load wheels are standard. Optional wheels: 3" and 6" single; 3" and 4" tandem. 6" steel caster wheels are standard. All wheels available in steel, polyurethane or phenolic. 3" wheel not available in phenolic.

OPTIONS

(other options available, consult factory)

- **Adjustable Straddle Option**
Available for the straddle I.D. range of 38" to 50". Adjusts in 4" increments. Will allow the truck to work with a variety of pallet sizes. Ideal if future pallet requirements may change.



SPECIFICATIONS

- Lifting Capacity:** 1,000 to 2,000 lbs. at 18" load centers.
1,500 to 2,500 lbs. at 24" load centers.
- Lift Range:** 57" - 144"
- Power System:** 12 volt with built-in charger.
- Turning Radius:** From 45 ¹¹/₁₆"

SPECIFICATIONS FOR ALL IBH MODELS

- Battery:**
 - 1018 Series: 12V, 125 A.H. polycase lead acid
 - 1518, 2018 Series: 12V, 125 A.H. polycase lead acid
 - 1524, 2024, 2524 Series: 12V, 155 A.H. polycase lead acid
- Charger:**
 - 1018, 1518, 2018 Series: 8 amp.
 - 1524, 2024, 2524 Series: 15 amp. fully automatic
- Forks:** See charts
- Wheel Diameter:**
 - Load wheels - 4"
 - Caster wheels - 6"
- Clearance:**
 - 1018, 1518, 2018 & 1524: 1 ⁹/₁₆" floor to bottom of straddle
 - 2024, 2524: 2 ¹/₁₆" floor to bottom of straddle

In-Between Handling Lift Trucks

Accessories & Attachments

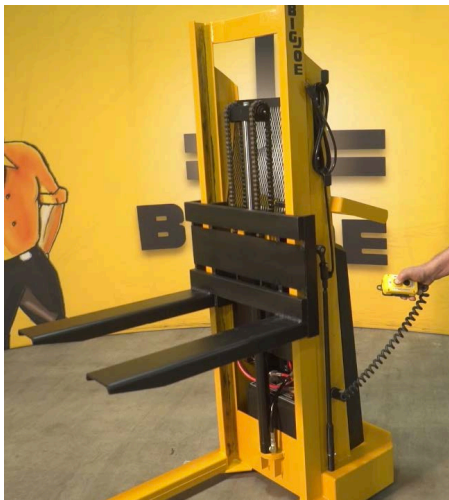

Roller Bed

Slip-on roller bed for side or front loading. 1000 lb. capacity. For rigid or adjustable forks.

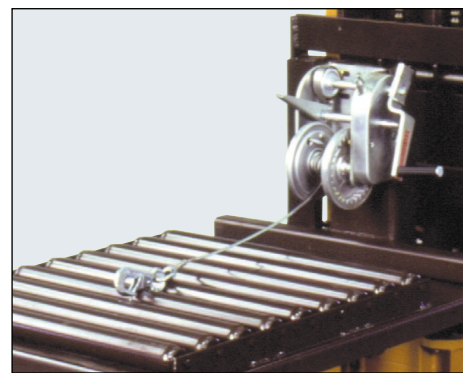

Die Puller

Front-load roller platform, 1000 lb. capacity (with proper straddles), complete with winch. Secures to rigid or adjustable forks.

Remote Lift/Lower Control

Pushbutton control. Magnetic clip-on.



Steer Wheel

The steer wheel configuration reduces steering effort and rolling resistance. This system improves maneuverability while making operation easier. Available for all models except 1000 lb. series. The attachment consists of dual 8" x 2" phenolic resin wheels and spring loaded "T" bar handle for maneuvering with rated loads. Not available on R6 or R7 models.

Ram

For coil and roll handling 2 1/2" x 26" is standard. Other lengths available.



Boom with Hook

Converts lift truck for portable crane operation. 26" long, 300 lb. capacity (500 lb. with proper straddles).



Removable Load Platform

Slip-on platform, in standard or special sizes, with smooth or non-slip surfaces, for rigid or adjustable forks. Not for personnel use.



In-Between Handling Lift Trucks

DIMENSIONS

ADJUSTABLE FORK MODELS

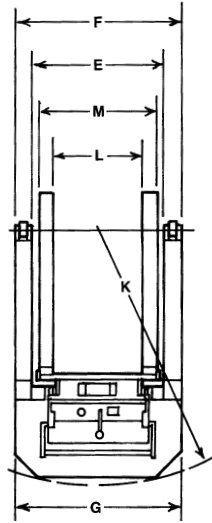

RIGID FORK MODELS

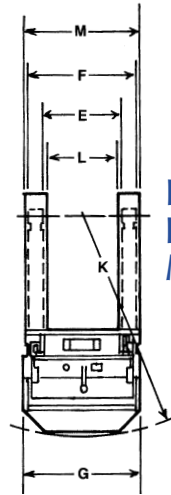

MODEL NO.	LIFT CAPACITY	LOAD CENTER	LIFT HEIGHT	COL. HEIGHT †		EXT. HEIGHT †	STRADDLES-STANDARD			OVERALL WIDTH	CHASSIS LENGTH **	OVERALL LENGTH ***	TURN RADIUS	FORKS STANDARD				SHIP WEIGHT
				A	B		C	LENGTH * D	I.D. E					O.D. F	I.D. (MIN) L	O.D. (MAX) M	LENGTH N	
1000 LBS. CAPACITY, 18" LOAD CENTER RIGID FORKS, NON-TELESCOPIC																		
1018-R5	1000	18	60	72	73 1/2	23 3/8	17	24	26 3/8	20 5/16	43 1 1/16	45 1 1/16	15 1/4	26	26 1/4	4 1/2	540	
1018-R6	1000	18	72	84	85 1/2	23 3/8	17	24	26 3/8	20 5/16	43 1 1/16	45 1 1/16	15 1/4	26	26 1/4	4 1/2	570	
1018-R7	1000	18	84	96	97 1/2	23 3/8	17	24	26 3/8	20 5/16	43 1 1/16	45 1 1/16	15 1/4	26	26 1/4	4 1/2	600	
ADJUSTABLE FORKS, NON-TELESCOPIC																		
1018-A5	1000	18	57	72	74	24 1/8	26	33	33 7/8	22 9/16	46 1 1/16	46 1 1/16	6	24	30	1 1/4	600	
1018-A6	1000	18	69	84	86	24 1/8	26	33	33 7/8	22 9/16	46 1 1/16	46 1 1/16	6	24	30	1 1/4	630	
1018-A7	1000	18	81	96	98	24 1/8	26	33	33 7/8	22 9/16	46 1 1/16	46 1 1/16	6	24	30	1 1/4	650	
1500 LBS. CAPACITY, 18" CENTER RIGID FORKS, NON-TELESCOPIC																		
1518-R5	1500	18	60	71 1/2	73 1/2	23 3/8	16 1/2	24 1/2	26 3/8	20 5/16	43 1 1/16	45 1 1/16	15 1/4	26	26 1/4	4 1/2	595	
1518-R6	1500	18	72	83 1/2	85 1/2	23 3/8	16 1/2	24 1/2	26 3/8	20 5/16	43 1 1/16	45 1 1/16	15 1/4	26	26 1/4	4 1/2	625	
1518-R7	1500	18	84	95 1/2	97 1/2	23 3/8	16 1/2	24 1/2	26 3/8	20 5/16	43 1 1/16	45 1 1/16	15 1/4	26	26 1/4	4 1/2	655	
ADJUSTABLE FORKS, NON-TELESCOPIC																		
1518-A5	1500	18	57	71 1/2	74	24 1/8	26	34	33 7/8	22 9/16	46 1 1/16	46 1 1/16	6	24	30	1 1/4	630	
1518-A6	1500	18	69	83 1/2	86	24 1/8	26	34	33 7/8	22 9/16	46 1 1/16	46 1 1/16	6	24	30	1 1/4	660	
1518-A7	1500	18	81	95 1/2	98	24 1/8	26	34	33 7/8	22 9/16	46 1 1/16	46 1 1/16	6	24	30	1 1/4	690	
ADJUSTABLE FORKS, TELESCOPIC																		
1518-T8	1500	18	96	69	116	23 7/8	30	38	37 7/8	22 13/16	46 1 1/16	47 1/4	9 3/4	28	30	1 3/4	850	
1518-T9	1500	18	108	75	128	23 7/8	30	38	37 7/8	22 13/16	46 1 1/16	47 1/4	9 3/4	28	30	1 3/4	880	
1518-T10	1500	18	120	81	140	23 7/8	42	50	49 7/8	22 13/16	46 1 1/16	49 9/16	9 3/4	28	30	1 3/4	930	
1518-T11	1500	18	132	87	152	23 7/8	42	50	49 7/8	22 13/16	46 1 1/16	49 9/16	9 3/4	28	30	1 3/4	960	
1518-T12	1500	18	144	93	164	23 7/8	42	50	49 7/8	22 13/16	46 1 1/16	49 9/16	9 3/4	28	30	1 3/4	990	
2000 LBS. CAPACITY, 18" CENTER RIGID FORKS, NON-TELESCOPIC																		
2018-R5	2000	18	60	71 1/2	73 1/2	23 3/16	16 1/2	24 1/2	26 3/8	20 5/16	43 1/2	45 1 1/16	15 1/4	26	26 1/4	4 1/2	635	
2018-R6	2000	18	72	83 1/2	85 1/2	23 3/16	16 1/2	24 1/2	26 3/8	20 5/16	43 1/2	45 1 1/16	15 1/4	26	26 1/4	4 1/2	675	
2018-R7	2000	18	84	95 1/2	97 1/2	23 3/16	16 1/2	24 1/2	26 3/8	20 5/16	43 1/2	45 1 1/16	15 1/4	26	26 1/4	4 1/2	715	
ADJUSTABLE FORKS, NON-TELESCOPIC																		
2018-A5	2000	18	57	71 1/2	74	23 1 1/16	26	34	33 7/8	22 13/16	46 1/2	46 1 1/16	6	24	30	1 1/2	665	
2018-A6	2000	18	69	83 1/2	86	23 1 1/16	26	34	33 7/8	22 13/16	46 1/2	46 1 1/16	6	24	30	1 1/2	705	
2018-A7	2000	18	81	95 1/2	98	23 1 1/16	26	34	33 7/8	22 13/16	46 1/2	46 1 1/16	6	24	30	1 1/2	745	
ADJUSTABLE FORKS, TELESCOPIC																		
2018-T8	2000	18	96	69	116	23 7/8	30	38	37 7/8	23 1/4	46 3/8	47 1/4	9 3/4	28	30	2	875	
2018-T9	2000	18	108	75	128	23 7/8	30	38	37 7/8	23 1/4	46 3/8	47 1/4	9 3/4	28	30	2	915	
2018-T10	2000	18	120	81	140	23 7/8	42	50	49 7/8	23 1/4	46 3/8	49 9/16	9 3/4	28	30	2	965	
2018-T11	2000	18	132	87	152	23 7/8	42	50	49 7/8	23 1/4	46 3/8	49 9/16	9 3/4	28	30	2	1005	
2018-T12	2000	18	144	93	164	23 7/8	42	50	49 7/8	23 1/4	46 3/8	49 9/16	9 3/4	28	30	2	1045	

*Face of fork to end of load wheels. **To face of fork. ***To end of load wheels. †For adjustable straddles add: 3 1/8"



In-Between Handling Lift Trucks

DIMENSIONS

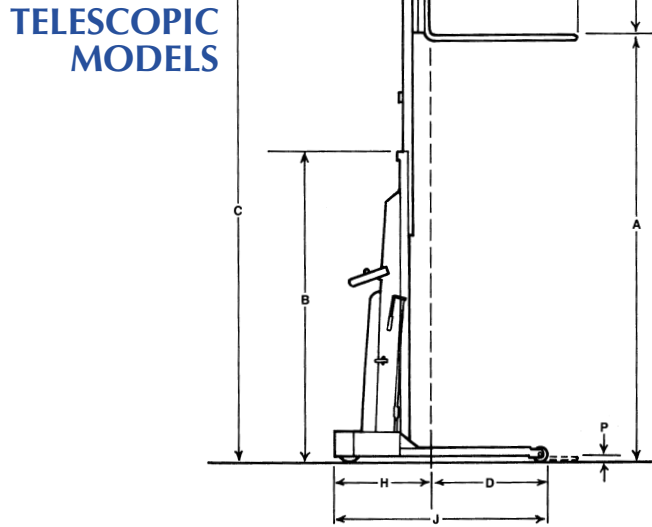
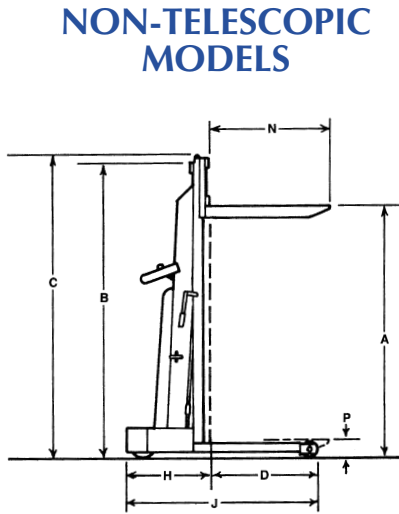

MODEL NO.	LIFT CAPACITY	LOAD CENTER	LIFT HEIGHT A	COL. HEIGHT B	EXT. HEIGHT C	STRADDLES-STANDARD			OVERALL WIDTH G	CHASSIS LENGTH ** H	OVERALL LENGTH *** J	TURN RADIUS K	FORKS STANDARD				SHIP. WEIGHT
						LENGTH * D	I.D. E	O.D. F					I.D. (MIN.) L	O.D. (MAX.) M	LENGTH N	LOWERED HEIGHT P	

**1500 LBS. CAPACITY, 24" LOAD CENTER
RIGID FORKS, NON-TELESCOPIC**

1524-A5	1500	24	57	71½	74	29 ³ / ₃₂	26	34	33 ⁷ / ₈	22 ¹³ / ₁₆	51 ²⁹ / ₃₂	51 ⁷ / ₈	6	24	36	1½	764
1524-A6	1500	24	69	83½	86	29 ³ / ₃₂	26	34	33 ⁷ / ₈	22 ¹³ / ₁₆	51 ²⁹ / ₃₂	51 ⁷ / ₈	6	24	36	1½	807
1524-A7	1500	24	81	95½	98	29 ³ / ₃₂	26	34	33 ⁷ / ₈	22 ¹³ / ₁₆	51 ²⁹ / ₃₂	51 ⁷ / ₈	6	24	36	1½	764

ADJUSTABLE FORKS, TELESCOPIC

1524-T8	1500	24	96	69	116	28 ¹ / ₂	30	38	37 ⁷ / ₈	23 ¹ / ₄	51 ³ / ₄	52 ³ / ₈	9 ³ / ₄	28	36	2	947
1524-T9	1500	24	108	75	128	28 ¹ / ₂	30	38	37 ⁷ / ₈	23 ¹ / ₄	51 ³ / ₄	52 ³ / ₈	9 ³ / ₄	28	36	2	972
1524-T10	1500	24	120	81	140	28 ¹ / ₂	42	50	49 ⁷ / ₈	23 ¹ / ₄	51 ³ / ₄	52 ³ / ₈	9 ³ / ₄	28	36	2	1032
1524-T11	1500	24	132	87	152	28 ¹ / ₂	42	50	49 ⁷ / ₈	23 ¹ / ₄	51 ³ / ₄	54 ¹ / ₂	9 ³ / ₄	28	36	2	1057
1524-T12	1500	24	144	93	164	28 ¹ / ₂	42	50	49 ⁷ / ₈	23 ¹ / ₄	51 ³ / ₄	54 ¹ / ₂	9 ³ / ₄	28	36	2	1082

**2000 LBS. CAPACITY, 24" LOAD CENTER
RIGID FORKS, NON-TELESCOPIC**

2024-A5	2000	24	60	77	79¼	28 ⁵ / ₈	42	50	49 ⁷ / ₈	24	52 ⁵ / ₈	49 ⁹ / ₁₆	6	28	36	1½	980
2024-A6	2000	24	72	89	91¼	28 ⁵ / ₈	42	50	49 ⁷ / ₈	24	52 ⁵ / ₈	49 ⁹ / ₁₆	6	28	36	1½	1020
2024-A7	2000	24	84	101	103¼	28 ⁵ / ₈	42	50	49 ⁷ / ₈	24	52 ⁵ / ₈	49 ⁹ / ₁₆	6	28	36	1½	1060

ADJUSTABLE FORKS, TELESCOPIC

2024-T8	2000	24	96	69	115¼	28 ¹ / ₂	30	38	37 ⁷ / ₈	24	52 ⁵ / ₈	54 ¹ / ₂	6	28	36	2	1285
2024-T9	2000	24	108	75	125¼	28 ¹ / ₂	30	38	37 ⁷ / ₈	24	52 ⁵ / ₈	49 ⁹ / ₁₆	6	28	36	2	1305
2024-T10	2000	24	120	81	139¼	28 ¹ / ₂	42	50	49 ⁷ / ₈	24	52 ⁵ / ₈	49 ⁹ / ₁₆	6	28	36	2	1365
2024-T11	2000	24	132	87	149¼	28 ¹ / ₂	42	50	49 ⁷ / ₈	24	52 ⁵ / ₈	49 ⁹ / ₁₆	6	28	36	2	1385
2024-T12	2000	24	144	93	163¼	28 ¹ / ₂	42	50	49 ⁷ / ₈	24	52 ⁵ / ₈	49 ⁹ / ₁₆	6	28	36	2	1405

**2500 LBS. CAPACITY, 24" LOAD CENTER
RIGID FORKS, NON-TELESCOPIC**

2524-A5	2500	24	60	77	79¼	28 ⁵ / ₈	42	50	49 ⁷ / ₈	24	52 ⁵ / ₈	49 ⁹ / ₁₆	6	28	36	1½	980
2524-A6	2500	24	72	89	91¼	28 ⁵ / ₈	42	50	49 ⁷ / ₈	24	52 ⁵ / ₈	49 ⁹ / ₁₆	6	28	36	1½	1020
2524-A7	2500	24	84	101	103¼	28 ⁵ / ₈	42	50	49 ⁷ / ₈	24	52 ⁵ / ₈	49 ⁹ / ₁₆	6	28	36	1½	1060

ADJUSTABLE FORKS, TELESCOPIC

2524-T8	2500	24	96	69	115¼	28 ¹ / ₂	30	38	37 ⁷ / ₈	24	52 ⁵ / ₈	54 ¹ / ₂	6	28	36	2	1285
2524-T9	2500	24	108	75	125¼	28 ¹ / ₂	30	38	37 ⁷ / ₈	24	52 ⁵ / ₈	49 ⁹ / ₁₆	6	28	36	2	1305
2524-T10	2500	24	120	81	139¼	28 ¹ / ₂	42	50	49 ⁷ / ₈	24	52 ⁵ / ₈	49 ⁹ / ₁₆	6	28	36	2	1365
2524-T11	2500	24	132	87	149¼	28 ¹ / ₂	42	50	49 ⁷ / ₈	24	52 ⁵ / ₈	49 ⁹ / ₁₆	6	28	36	2	1385
2524-T12	2500	24	144	93	163¼	28 ¹ / ₂	42	50	49 ⁷ / ₈	24	52 ⁵ / ₈	49 ⁹ / ₁₆	6	28	36	2	1405

*Face of fork to end of load wheels. **To face of fork. ***To end of load wheels. †For adjustable straddles add: 3¹/₈"